

+4V0IN\I

PASAGND\I

+3V3IN\I

+4V0\I

(FOR THE 3.3V PWR. REG.)

+3V3_DIG\I

+3V3\I
(FOR THE 2.5V PWR. REG.)

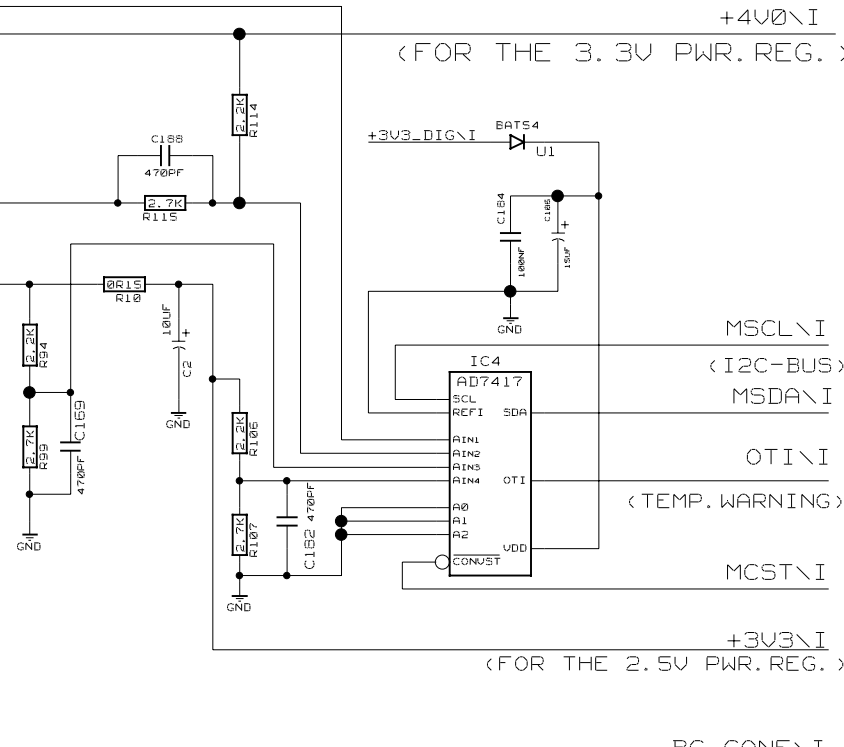
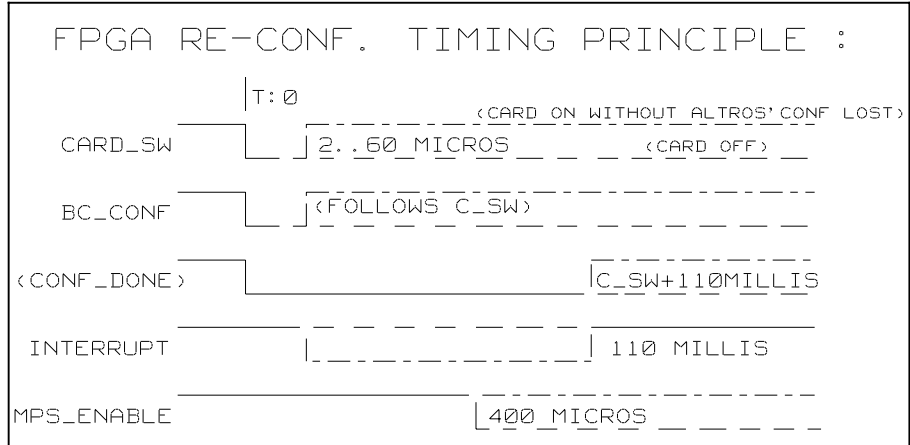

CARD_SW\I

(FROM BACKPLANE CONN)

CARD_SWAUX\I

(FROM I2C CONNECTOR)

BC_INT\I

(ACTIVE LOW)

MPS_ERROR\I

(OPEN DRAIN - ACTIVE LOW)

(240 MV FOR 39151 ERROR FLG / 40 MV FOR TC1173 ERROR FLG)

+4V0\I

BC_CONF\I

MPS_ENABLE\I

INTERRUPT\I

(OPEN COLLECTOR OUTPUT 'OR-WIRED' TO THE BUS WITH COMMON PULL-UP TERMINATION RESISTOR)

PULL-DOWN REQUIRED TO COMPENSATE DRIFTING CURRENTS WHEN FPGA IS NOT PROGRAMMED

EDMS REF: X		VERSION: X		PCB: X		SYSTEM: X	
REF: 40021090				TITLE: POWER_CTRL			
		DIV. PH - ED		ABBREV: PCTRL		PAGE: 2/14	
		1211 GENEVA 23 SWITZERLAND		LAST_MODIFIED=Mon Jan 26 14:10:30 2004			
		DESSIN: R. CAMPAGNOLO		ETUDE: R. C.		DATE: 10.05.03	

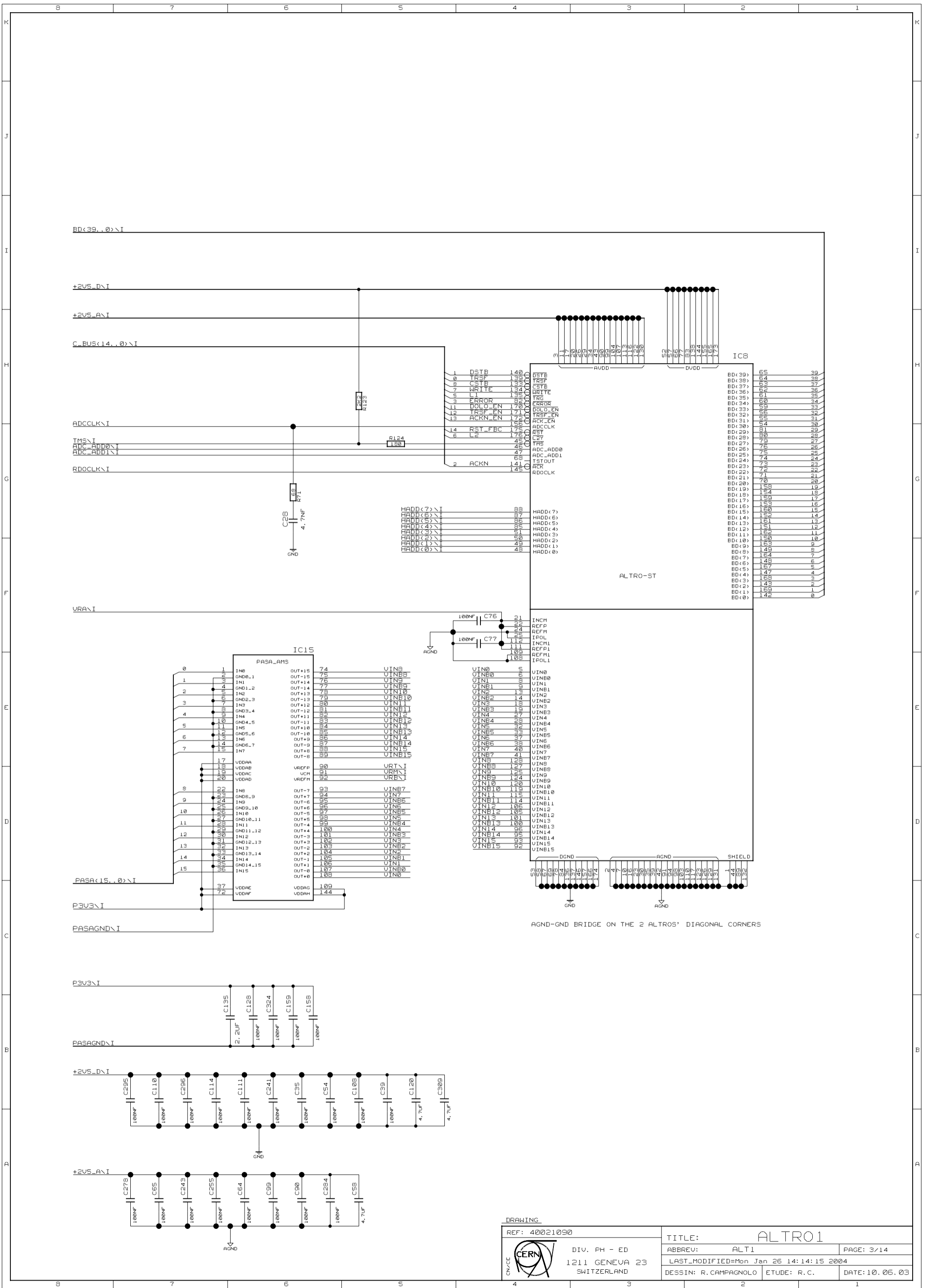

BD<39..0>\I

+2V5_D\I

+2V5_A\I

C_BUS<14..0>\I

ADCCLK\I

TMS\I

ADC_ADD0\I

ADC_ADD1\I

RDOCLK\I

URAV\I

PASA<15..0>\I

P3V3\I

PASAGND\I

P3V3\I

PASAGND\I

+2V5_D\I

+2V5_A\I

1	DSTB	140	DSTB	55	39
0	TRSF	139	TRSF	54	38
8	CSTB	138	CSTB	53	37
7	WRITE	137	WRITE	52	36
6	LI	136	LI	51	35
5	ERROR	135	ERROR	50	34
11	DOLO_EN	170	DOLO_EN	49	33
12	TRSF_EN	171	TRSF_EN	48	32
13	ACKN_EN	172	ACKN_EN	47	31
14	RST_FBC	175	RST_FBC	46	30
E	LP	176	LP	45	29
4	ACKN	141	ACKN	44	28
148			ACKN	43	27
			ACKN	42	26
			ACKN	41	25
			ACKN	40	24
			ACKN	39	23
			ACKN	38	22
			ACKN	37	21
			ACKN	36	20
			ACKN	35	19
			ACKN	34	18
			ACKN	33	17
			ACKN	32	16
			ACKN	31	15
			ACKN	30	14
			ACKN	29	13
			ACKN	28	12
			ACKN	27	11
			ACKN	26	10
			ACKN	25	9
			ACKN	24	8
			ACKN	23	7
			ACKN	22	6
			ACKN	21	5
			ACKN	20	4
			ACKN	19	3
			ACKN	18	2
			ACKN	17	1
			ACKN	16	0

HADD<7>\I	0	HADD<7>
HADD<6>\I	1	HADD<6>
HADD<5>\I	2	HADD<5>
HADD<4>\I	3	HADD<4>
HADD<3>\I	4	HADD<3>
HADD<2>\I	5	HADD<2>
HADD<1>\I	6	HADD<1>
HADD<0>\I	7	HADD<0>



INC1	111	INC1	111	VIN0
REFP1	112	REFP1	112	VIN0
REFM1	113	REFM1	113	VIN0
IPOL1	114	IPOL1	114	VIN0
INC1	115	INC1	115	VIN0
REFP1	116	REFP1	116	VIN0
REFM1	117	REFM1	117	VIN0
IPOL1	118	IPOL1	118	VIN0
INC1	119	INC1	119	VIN0
REFP1	120	REFP1	120	VIN0
REFM1	121	REFM1	121	VIN0
IPOL1	122	IPOL1	122	VIN0
INC1	123	INC1	123	VIN0
REFP1	124	REFP1	124	VIN0
REFM1	125	REFM1	125	VIN0
IPOL1	126	IPOL1	126	VIN0
INC1	127	INC1	127	VIN0
REFP1	128	REFP1	128	VIN0
REFM1	129	REFM1	129	VIN0
IPOL1	130	IPOL1	130	VIN0
INC1	131	INC1	131	VIN0
REFP1	132	REFP1	132	VIN0
REFM1	133	REFM1	133	VIN0
IPOL1	134	IPOL1	134	VIN0
INC1	135	INC1	135	VIN0
REFP1	136	REFP1	136	VIN0
REFM1	137	REFM1	137	VIN0
IPOL1	138	IPOL1	138	VIN0
INC1	139	INC1	139	VIN0
REFP1	140	REFP1	140	VIN0
REFM1	141	REFM1	141	VIN0
IPOL1	142	IPOL1	142	VIN0

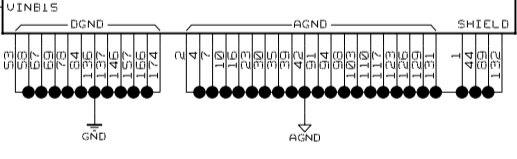

AGND-GND BRIDGE ON THE 2 ALTROS' DIAGONAL CORNERS

IN0	74	VIN0
OUT+15	75	VIN0
OUT+14	76	VIN0
OUT+13	77	VIN0
OUT+12	78	VIN0
OUT+11	79	VIN0
OUT+10	80	VIN0
OUT+9	81	VIN0
OUT+8	82	VIN0
OUT+7	83	VIN0
OUT+6	84	VIN0
OUT+5	85	VIN0
OUT+4	86	VIN0
OUT+3	87	VIN0
OUT+2	88	VIN0
OUT+1	89	VIN0
OUT+0	90	VIN0
OUT-15	91	VIN0
OUT-14	92	VIN0
OUT-13	93	VIN0
OUT-12	94	VIN0
OUT-11	95	VIN0
OUT-10	96	VIN0
OUT-9	97	VIN0
OUT-8	98	VIN0
OUT-7	99	VIN0
OUT-6	100	VIN0
OUT-5	101	VIN0
OUT-4	102	VIN0
OUT-3	103	VIN0
OUT-2	104	VIN0
OUT-1	105	VIN0
OUT+0	106	VIN0
OUT-0	107	VIN0
OUT+0	108	VIN0
OUT-0	109	VIN0
OUT+0	110	VIN0
OUT-0	111	VIN0
OUT+0	112	VIN0
OUT-0	113	VIN0
OUT+0	114	VIN0
OUT-0	115	VIN0
OUT+0	116	VIN0
OUT-0	117	VIN0
OUT+0	118	VIN0
OUT-0	119	VIN0
OUT+0	120	VIN0
OUT-0	121	VIN0
OUT+0	122	VIN0
OUT-0	123	VIN0
OUT+0	124	VIN0
OUT-0	125	VIN0
OUT+0	126	VIN0
OUT-0	127	VIN0
OUT+0	128	VIN0
OUT-0	129	VIN0
OUT+0	130	VIN0
OUT-0	131	VIN0
OUT+0	132	VIN0
OUT-0	133	VIN0
OUT+0	134	VIN0
OUT-0	135	VIN0
OUT+0	136	VIN0
OUT-0	137	VIN0
OUT+0	138	VIN0
OUT-0	139	VIN0
OUT+0	140	VIN0
OUT-0	141	VIN0
OUT+0	142	VIN0
OUT-0	143	VIN0
OUT+0	144	VIN0
OUT-0	145	VIN0
OUT+0	146	VIN0
OUT-0	147	VIN0
OUT+0	148	VIN0
OUT-0	149	VIN0
OUT+0	150	VIN0
OUT-0	151	VIN0
OUT+0	152	VIN0
OUT-0	153	VIN0
OUT+0	154	VIN0
OUT-0	155	VIN0
OUT+0	156	VIN0
OUT-0	157	VIN0
OUT+0	158	VIN0
OUT-0	159	VIN0
OUT+0	160	VIN0
OUT-0	161	VIN0
OUT+0	162	VIN0
OUT-0	163	VIN0
OUT+0	164	VIN0
OUT-0	165	VIN0
OUT+0	166	VIN0
OUT-0	167	VIN0
OUT+0	168	VIN0
OUT-0	169	VIN0
OUT+0	170	VIN0
OUT-0	171	VIN0
OUT+0	172	VIN0
OUT-0	173	VIN0
OUT+0	174	VIN0
OUT-0	175	VIN0
OUT+0	176	VIN0
OUT-0	177	VIN0
OUT+0	178	VIN0
OUT-0	179	VIN0
OUT+0	180	VIN0
OUT-0	181	VIN0
OUT+0	182	VIN0
OUT-0	183	VIN0
OUT+0	184	VIN0
OUT-0	185	VIN0
OUT+0	186	VIN0
OUT-0	187	VIN0
OUT+0	188	VIN0
OUT-0	189	VIN0
OUT+0	190	VIN0
OUT-0	191	VIN0
OUT+0	192	VIN0
OUT-0	193	VIN0
OUT+0	194	VIN0
OUT-0	195	VIN0
OUT+0	196	VIN0
OUT-0	197	VIN0
OUT+0	198	VIN0
OUT-0	199	VIN0
OUT+0	200	VIN0

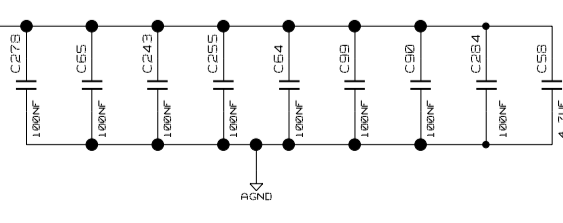
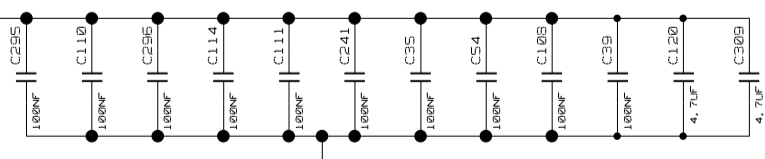
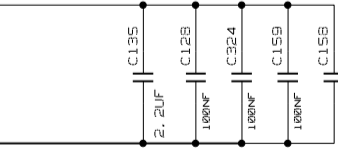

DRAWING REF: 40021090

CERN DIV. PH - ED 1211 GENEVA 23 SWITZERLAND

TITLE: ALTRO1

ABBREU: ALT1

LAST_MODIFIED: Mon Jan 26 14:14:15 2004

DESSIN: R. CAMPANOLO

ETUDE: R. C.

PAGE: 3/14

DATE: 10.06.03

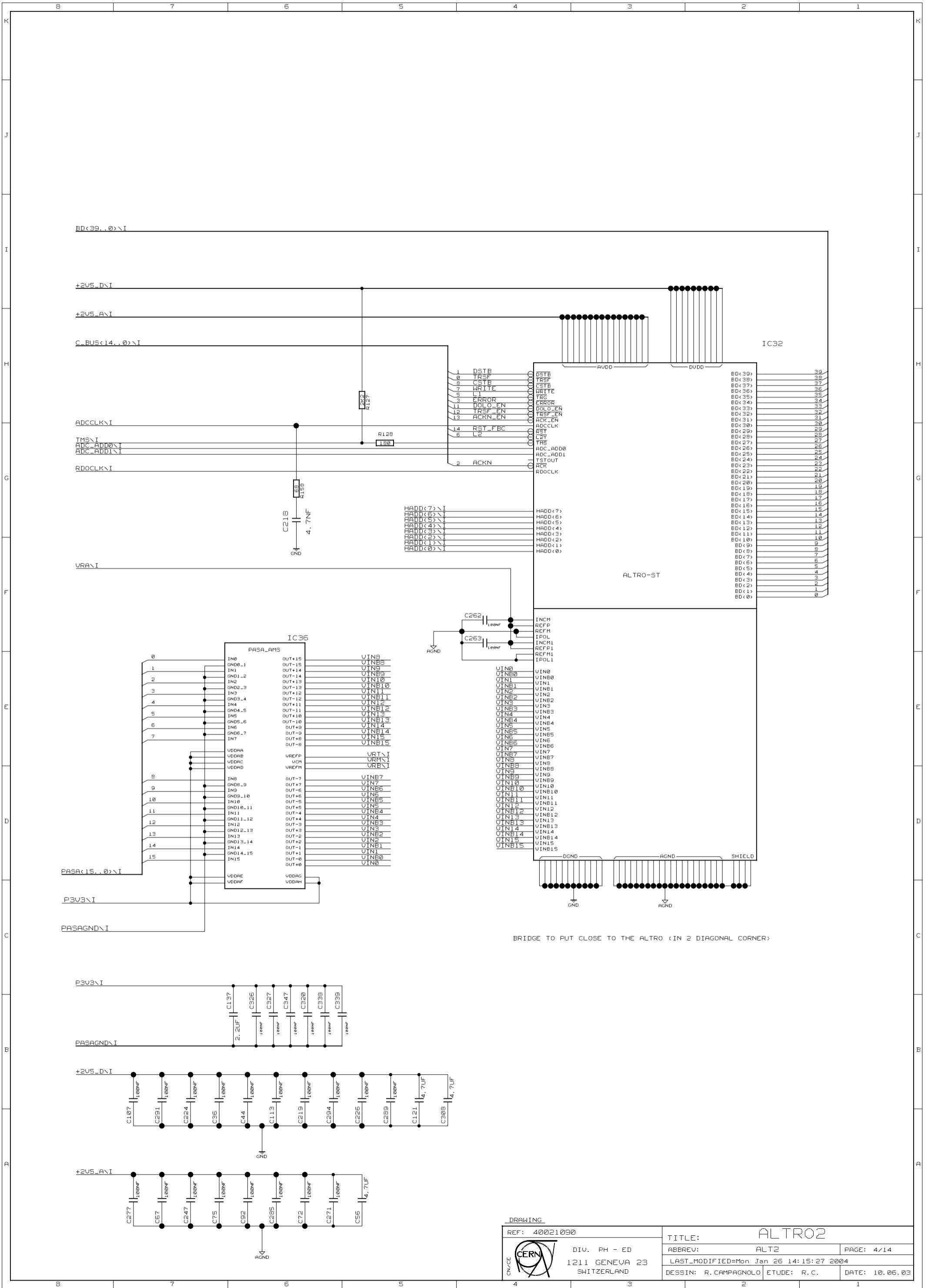

DRAWING		REF: 40021090		TITLE: ALTR02	
CERN		DIV. PH - ED		ABBREU: ALT2	
1211 GENEVA 23		SWITZERLAND		PAGE: 4/14	
				LAST_MODIFIED=Mon Jan 26 14:15:27 2004	
				DESSIN: R. CAMPAGNOLO	
				ETUDE: R. C.	
				DATE: 10.05.03	

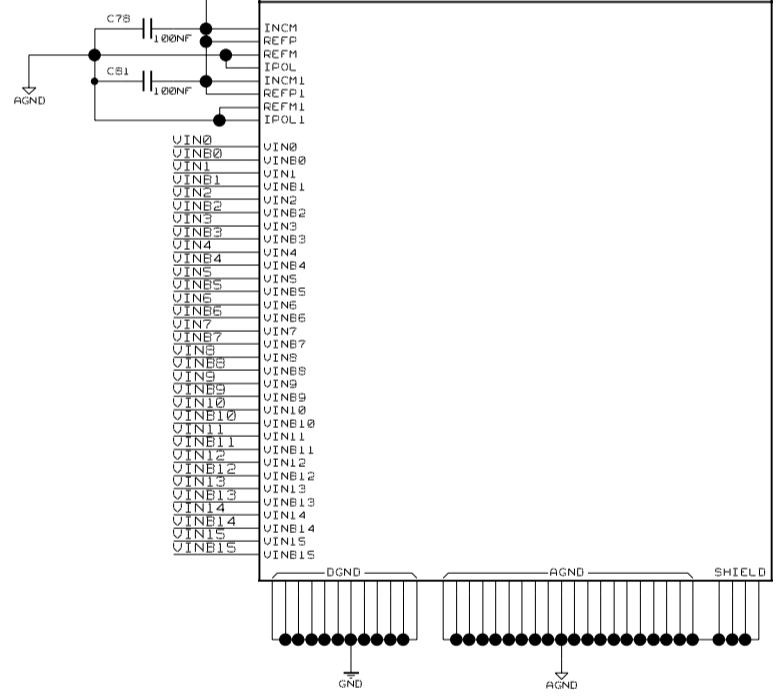
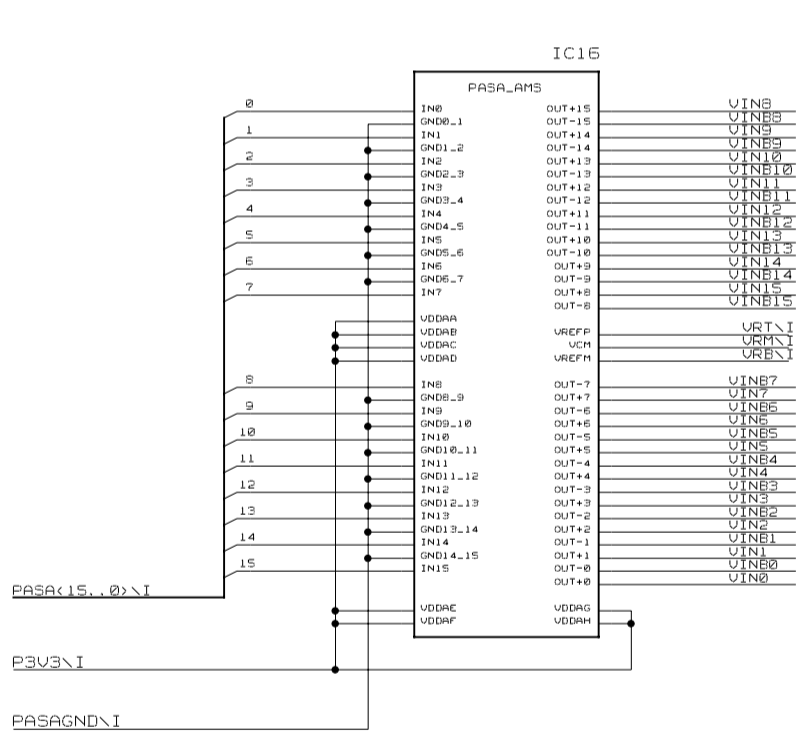
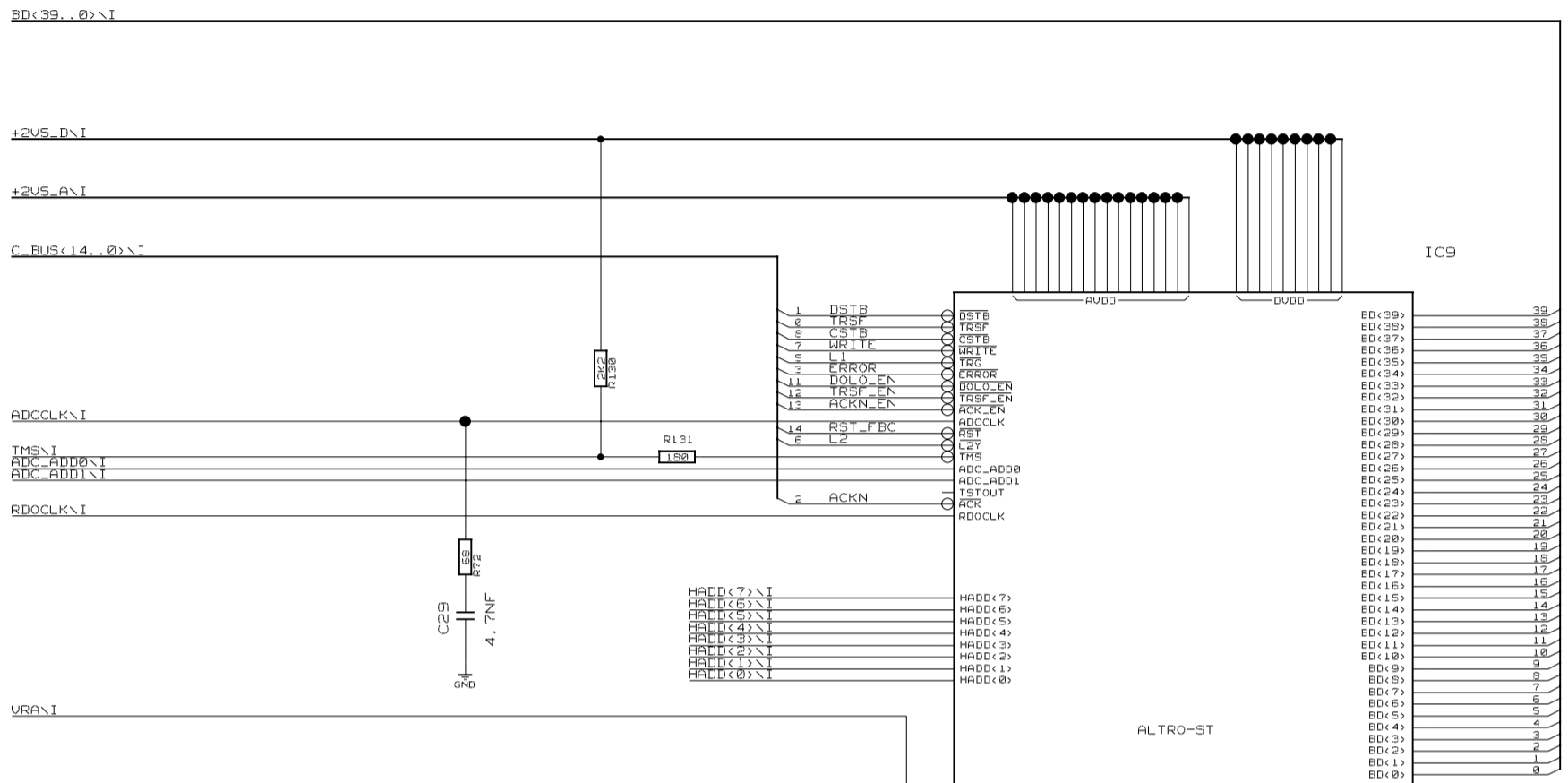

BRIDGE TO PUT CLOSE TO THE ALTRO (IN 2 DIAGONAL CORNER)

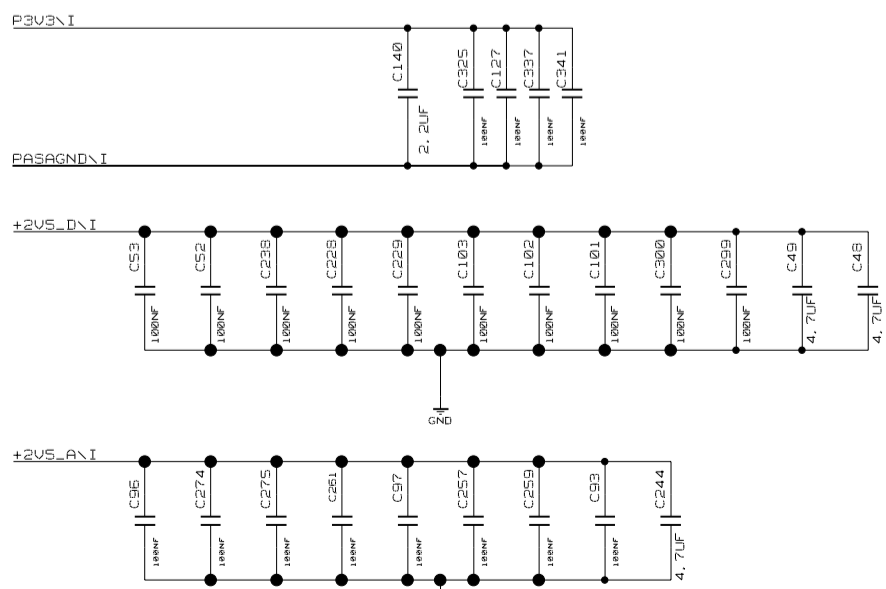

DRAWING		TITLE: ALTRO3	
REF: 40021090	DIV. PH - ED		PAGE: 5/14
	1211 GENEVA 23		LAST_MODIFIED=Mon Jan 26 10:57:42 2004
	SWITZERLAND		DESSIN: R.CAMPAGNOLO
		ETUDE: R.C.	DATE: 10.06.03

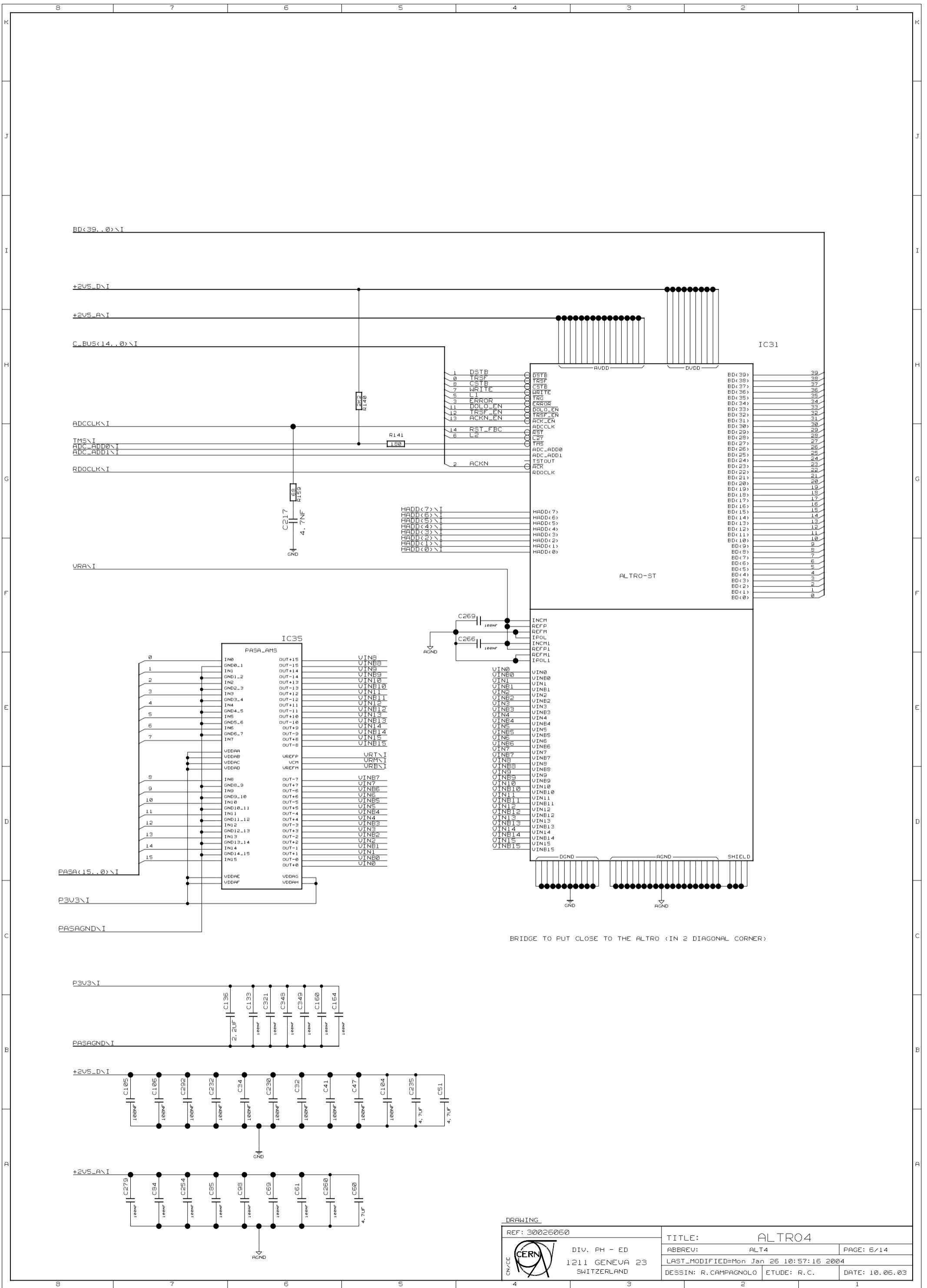

DRAWING		REF: 30025050		TITLE: ALTRO4	
		DIV. PH - ED		ABBREU: ALT4	
		1211 GENEVA 23		LAST_MODIFIED=Mon Jan 26 10:57:16 2004	
SWITZERLAND		DESSIN: R.CAMPAGNOLO		ETUDE: R.C.	
				DATE: 10.06.03	

BRIDGE TO PUT CLOSE TO THE ALTRO (IN 2 DIAGONAL CORNER)

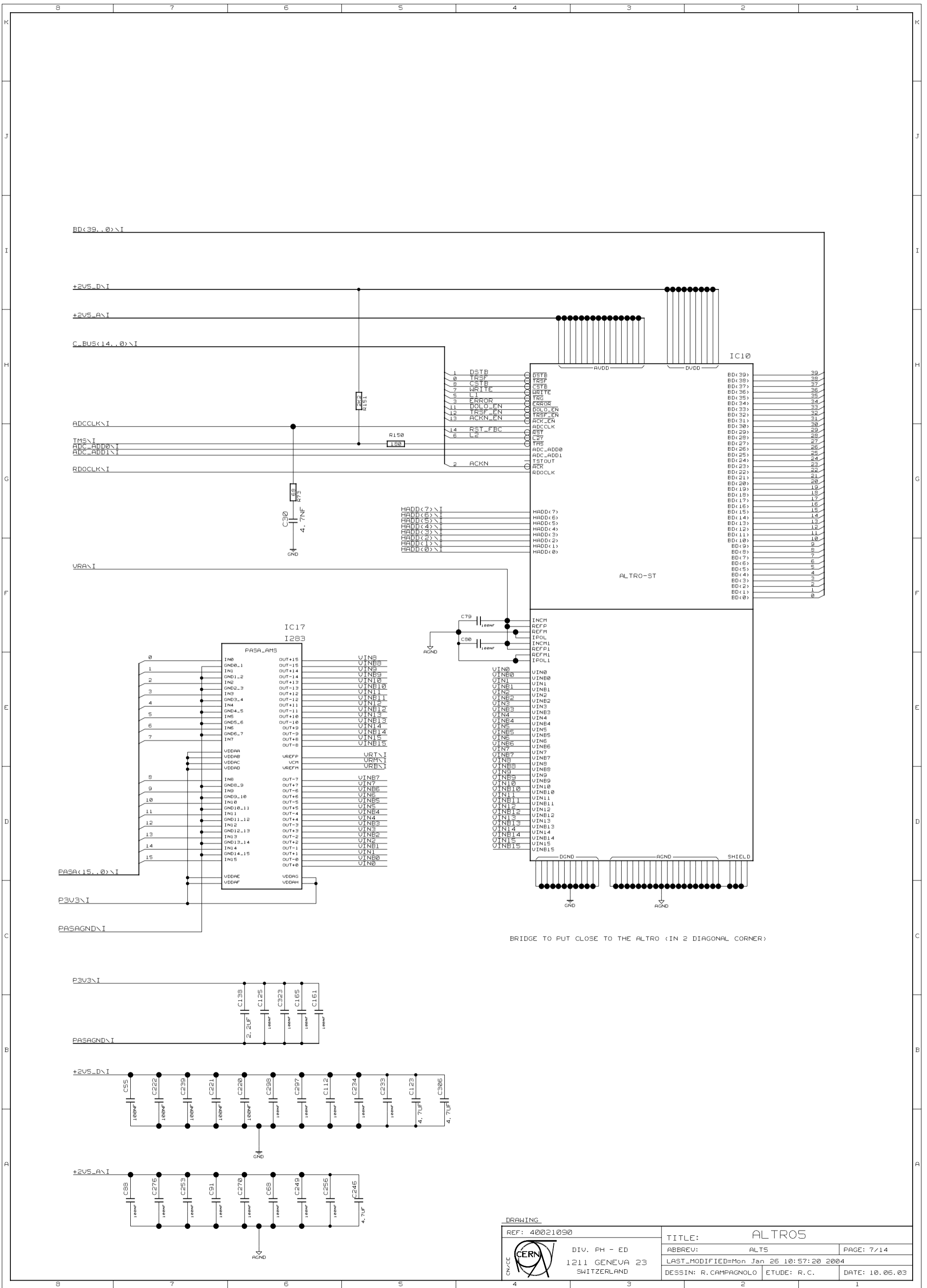

DRAWING		TITLE: ALTRO5	
REF: 40021090		ABBREU: ALTS	PAGE: 7/14
		DIV. PH - ED	
		1211 GENEVA 23 SWITZERLAND	
DESSIN: R. CAMPAGNOLO		ETUDE: R. C.	DATE: 10.06.03

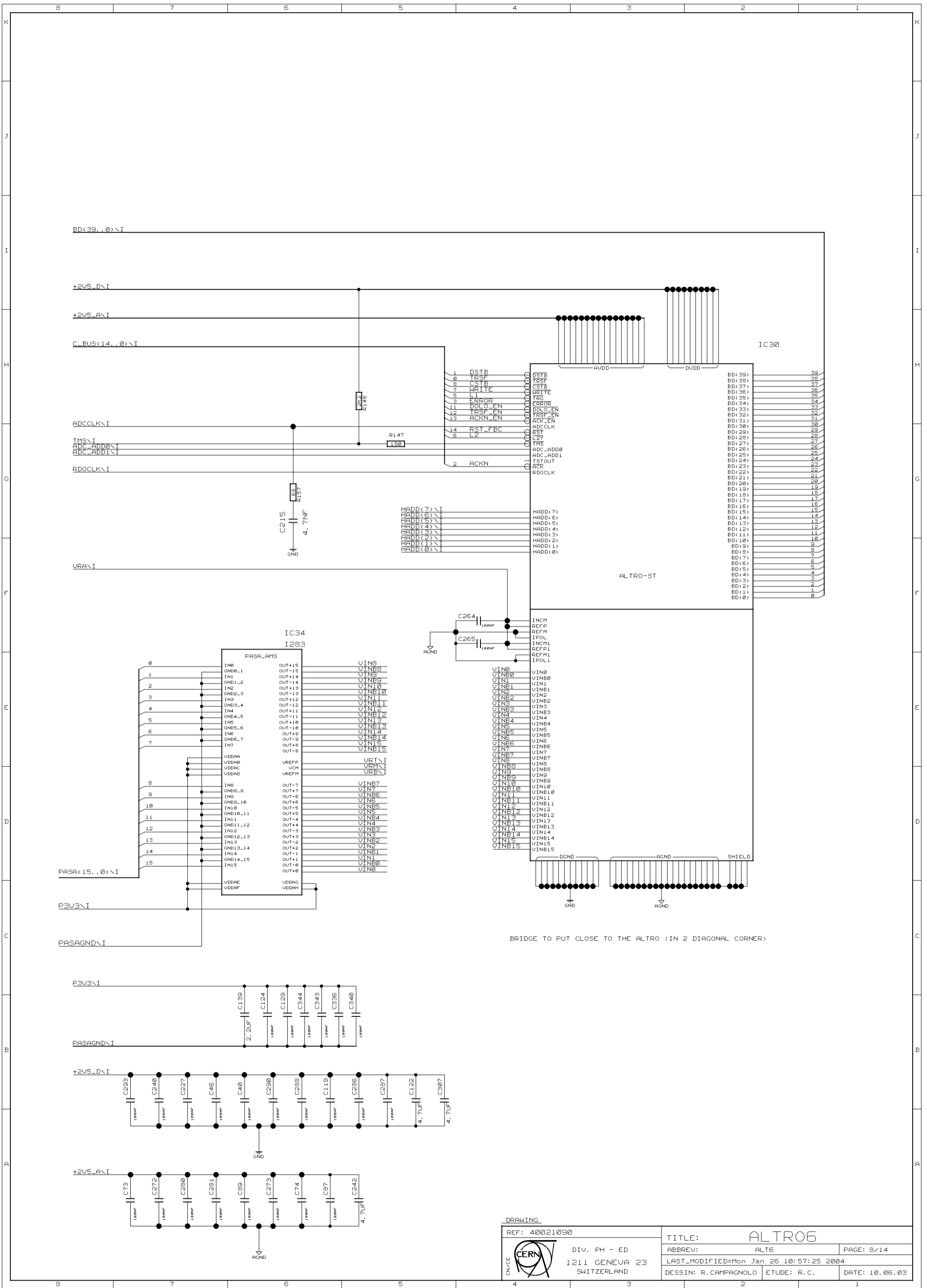

DRAWING		TITLE: ALTRO6	
REF: 40021090	DIV. PH - ED	ABBREU: ALT6	PAGE: 8/14
	1211 GENEVA 23	LAST_MODIFIED: Mon Jan 26 10:57:25 2004	
	SWITZERLAND	DESSIN: R.CAMPAGNOLO	ETUDE: R.C.
			DATE: 10.06.03

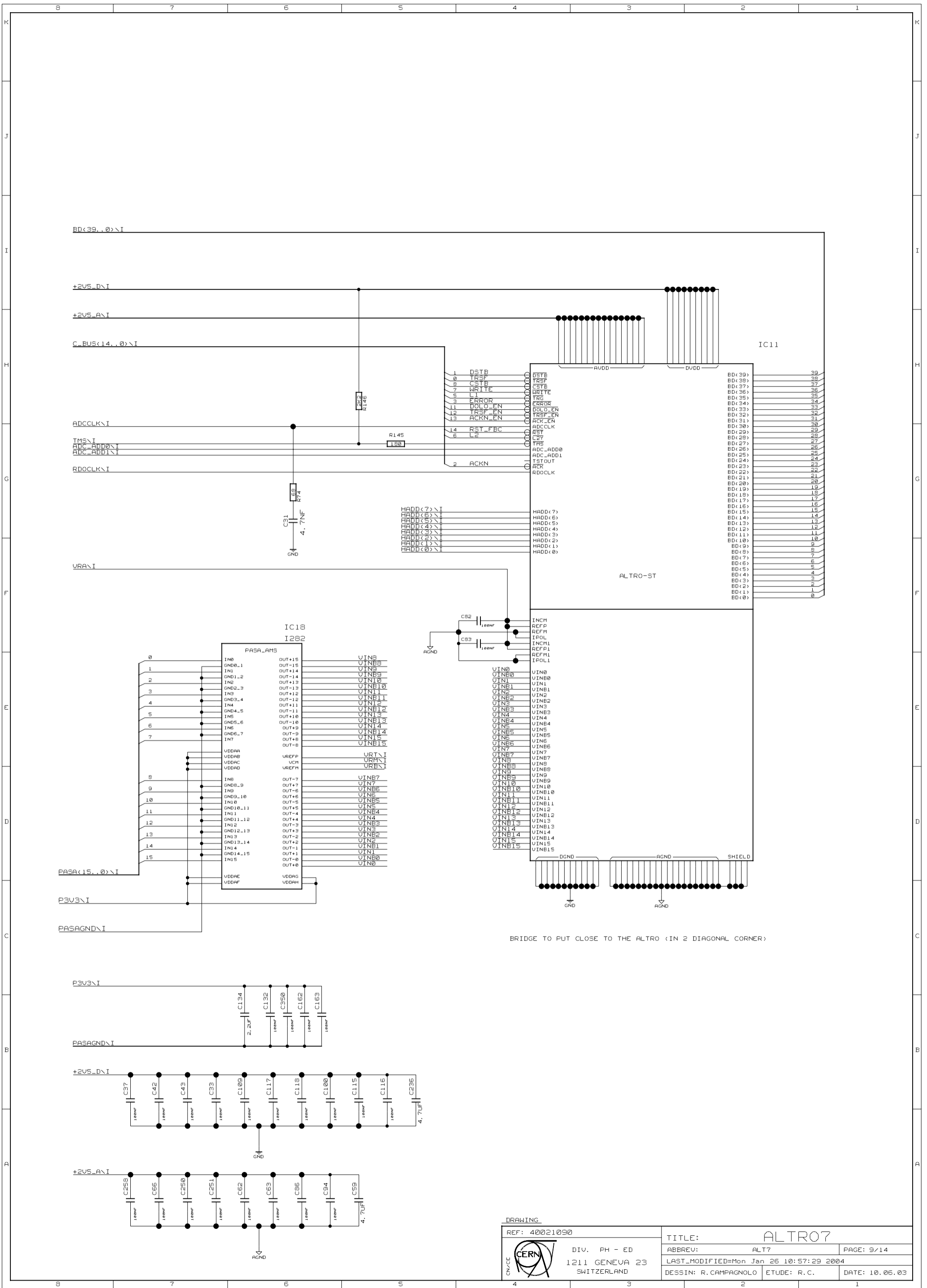

DRAWING		REF: 40021090		TITLE: ALTRO7	
CERN		DIV. PH - ED		ABBREU: ALT7	
1211 GENEVA 23		SWITZERLAND		PAGE: 9/14	
DESSIN: R.CAMPAGNOLO		ETUDE: R.C.		DATE: 10.06.03	

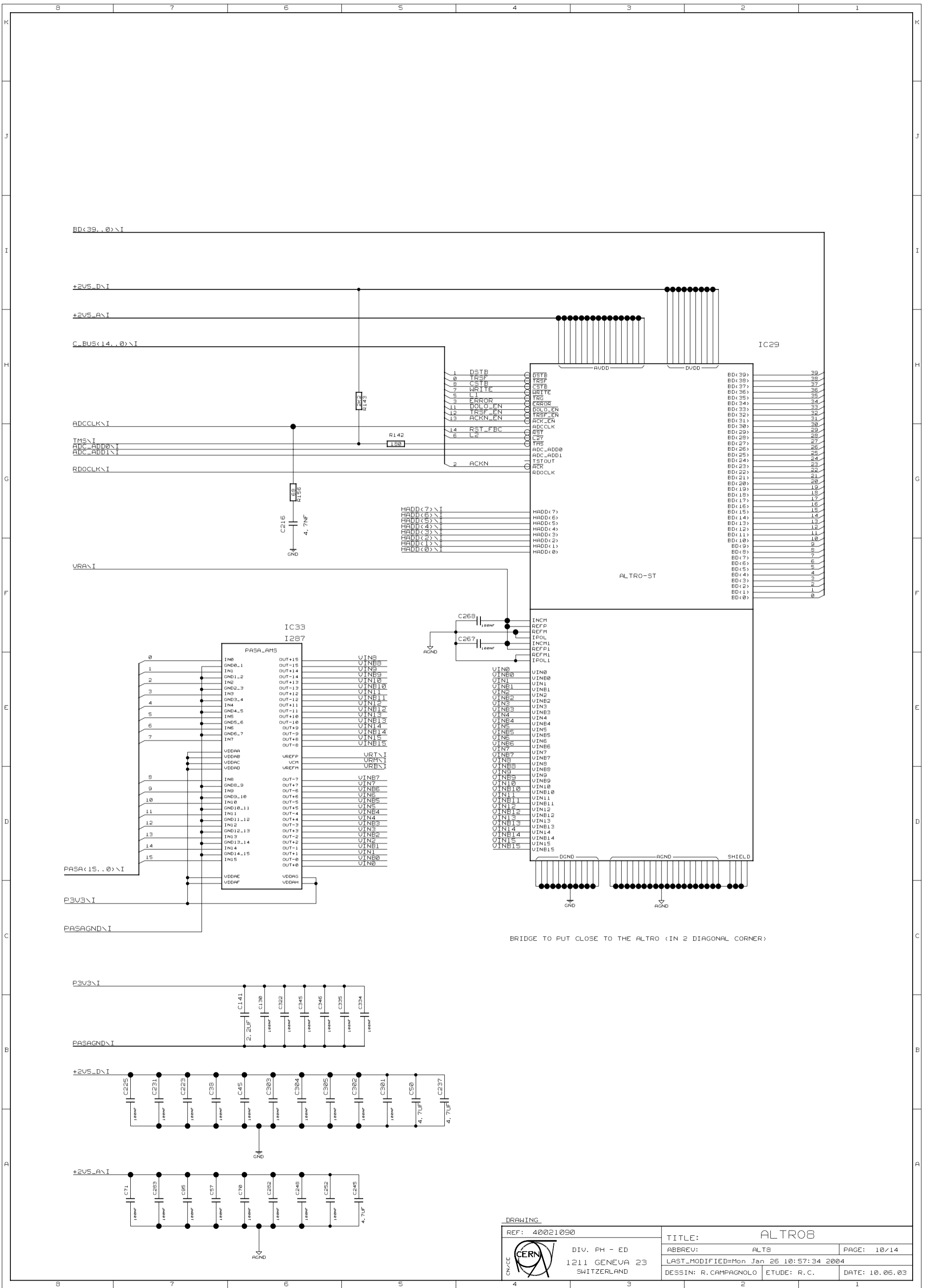

DRAWING		REF: 40021090		TITLE: ALTRO8	
	DIV. PH - ED		ABBREU: ALTB		PAGE: 10/14
	1211 GENEVA 23		LAST_MODIFIED: Mon Jan 26 10:57:34 2004		
	SWITZERLAND		DESSIN: R.CAMPAGNOLO		ETUDE: R.C.
				DATE: 10.06.03	

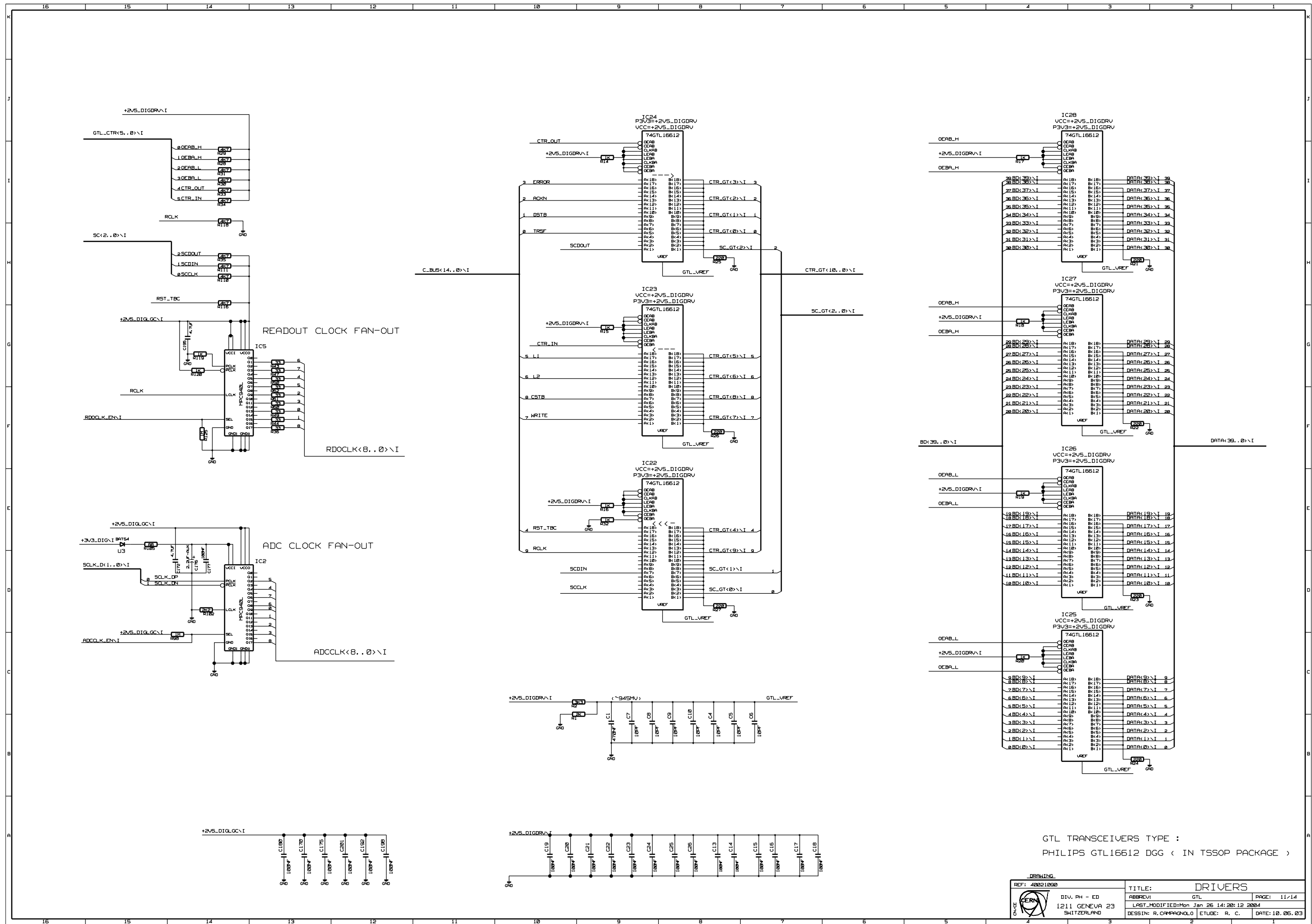

GTL TRANSCEIVERS TYPE :
 PHILIPS GTL16612 DGG < IN TSSOP PACKAGE >

DRAWING		TITLE: DRIVERS	
REF: 40021090	DIV. PH - ED	ABBREVI: GTL	PAGE: 11/14
1211 GENEVA 23		LAST_MODIFIED=Mon Jan 26 14:20:12 2004	
SWITZERLAND		DESSIN: R. CAMPANOLO ETUDE: R. C. DATE: 10.05.03	

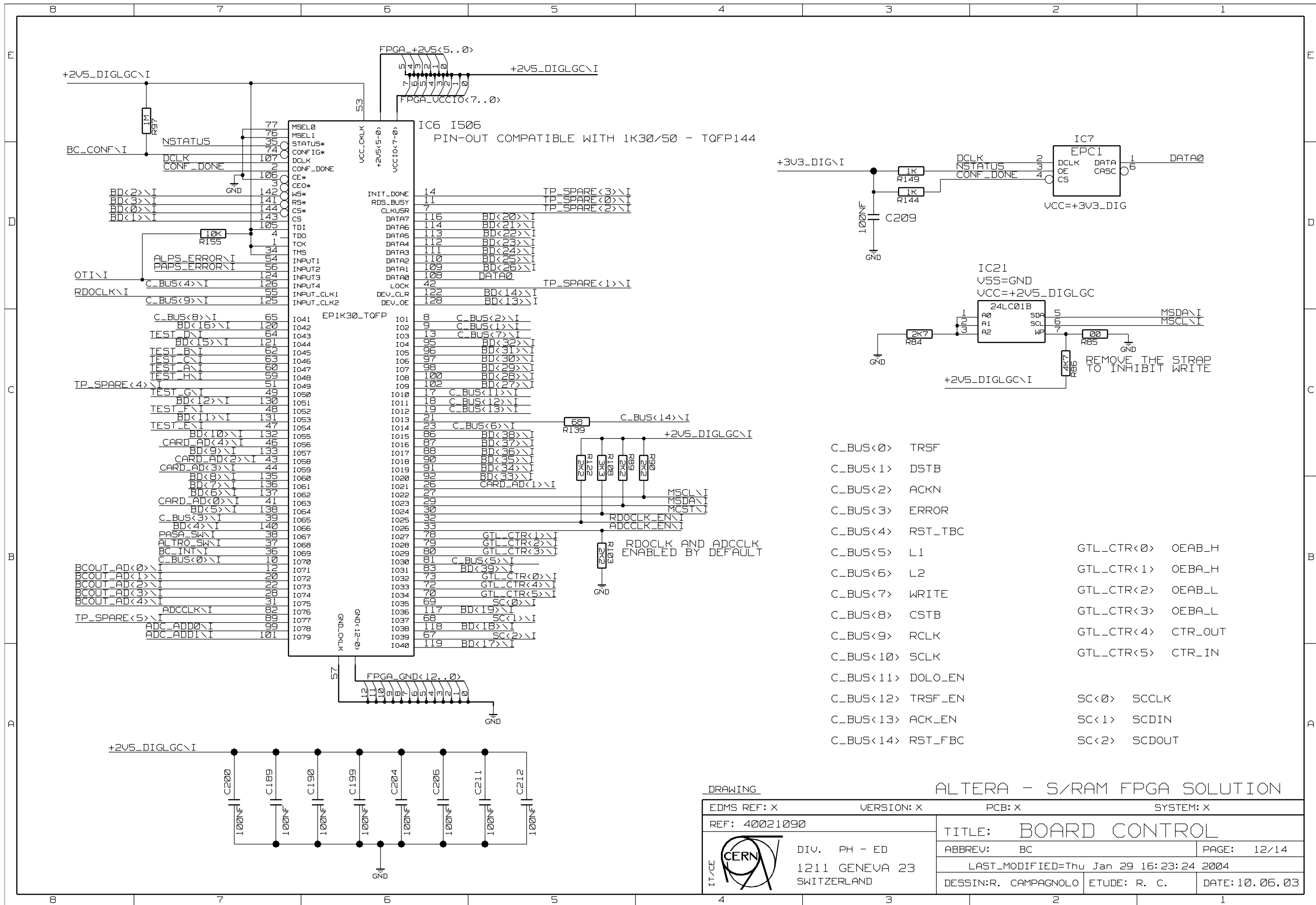

- C_BUS<0> TRSF
- C_BUS<1> DSTB
- C_BUS<2> ACKN
- C_BUS<3> ERROR
- C_BUS<4> RST_TBC
- C_BUS<5> L1
- C_BUS<6> L2
- C_BUS<7> WRITE
- C_BUS<8> CSTB
- C_BUS<9> RCLK
- C_BUS<10> SCLK
- C_BUS<11> DOLO_EN
- C_BUS<12> TRSF_EN
- C_BUS<13> ACK_EN
- C_BUS<14> RST_FBC
- GTL_CTR<0> OEAB_H
- GTL_CTR<1> OEBA_H
- GTL_CTR<2> OEAB_L
- GTL_CTR<3> OEBA_L
- GTL_CTR<4> CTR_OUT
- GTL_CTR<5> CTR_IN
- SC<0> SCCLK
- SC<1> SCDIN
- SC<2> SCDOUT

DRAWING ALTERA - S/DRAM FPGA SOLUTION

EDMS REF: X	VERSION: X	PCB: X	SYSTEM: X
REF: 40021090		TITLE: BOARD CONTROL	
 DIV. PH - ED 1211 GENEVA 23 SWITZERLAND	ABBREV: BC	PAGE: 12/14	
	LAST_MODIFIED=Thu Jan 29 16:23:24 2004		
	DESSIN:R. CAMPAGNOLO	ETUDE: R. C.	DATE: 10.06.03

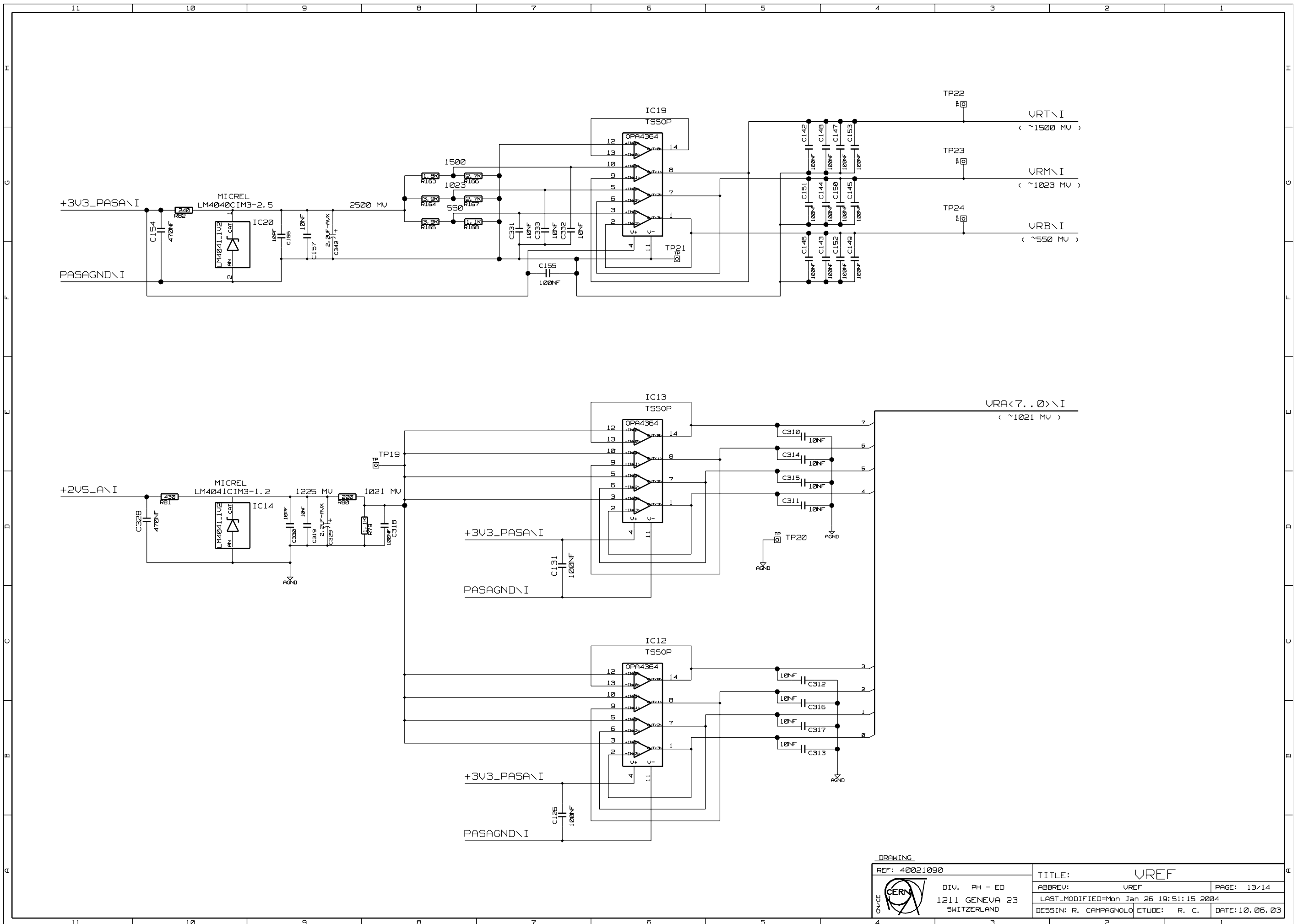

DRAWING		TITLE: VREF	
REF: 40021090	DIV. PH - ED	ABBREV: VREF	PAGE: 13/14
	1211 GENEVA 23	LAST_MODIFIED=Mon Jan 26 19:51:15 2004	
	SWITZERLAND	DESSIN: R. CAMPAGNOLO	ETUDE: R. C. DATE: 10.06.03

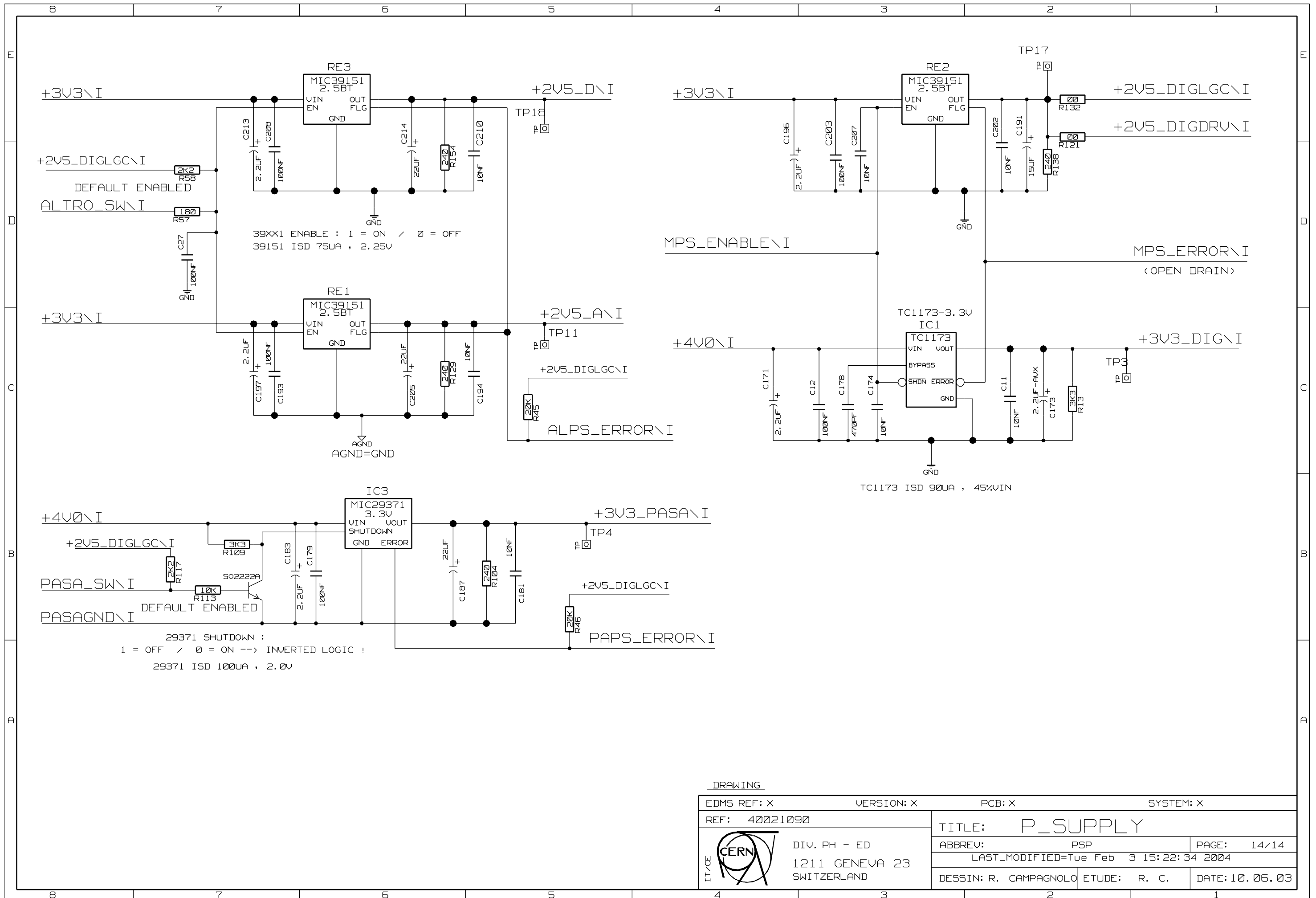

DRAWING

EDMS REF: X	VERSION: X	PCB: X	SYSTEM: X
REF: 40021090		TITLE: P_SUPPLY	
 DIV. PH - ED 1211 GENEVA 23 SWITZERLAND	ABBREV: PSP	PAGE: 14/14	
	LAST_MODIFIED= Tue Feb 3 15:22:34 2004		
	DESSIN: R. CAMPAGNOLO	ETUDE: R. C.	DATE: 10.06.03